

HMF 340-K



- power to lift.

HMF Knuckle Boom Loader 340-K

A sturdy and versatile Loader with great Flexibility

- Compact design with short platform length offers good utilization of the truck body.
- A smaller loader designed with the big loader's characteristics.
- Available up to three hydraulic extensions as well as manual extensions.
- Equipped with link arm offering both increased hook height close to the column and increased lifting capacity at long reach.
- Reliable and sturdy design.
- Available with radio remote control as an option.
- Available with 2 extra valves for grab and rotator.

Loading group B3		340-K1	340-K2	340-K3
Load moment	tm	3.2	3.2	3.2
Hydraulic reach	m	4.4	5.7	7.1
Slewing torque	kgm	550	600	600
Slewing angle	°	370	370	370
Height above chassis	mm	1591	1591	1591
Width, folded, standard	mm	1700	1700	1700
Width, folded, extra	mm	2000	2000	2000
Length of base, no extra valves	mm	516	516	516
Stabilizer spread, standard	mm	3300	3300	3300
Stabilizer spread, long	mm	3900	3900	3900
Weight excl. stabilizers	kg	418	468	508
Weight of stabilizers, standard	kg	72	72	72
Working pressure	MPa	22.0	24.0	24.0
Pump performance	l/min	15	15	12
Power consumption	kW	5.5	6.0	5.0
Oli tank capacity, separate tank	l	20	20	20

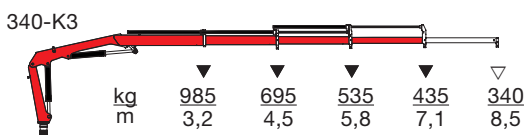
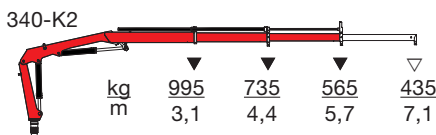
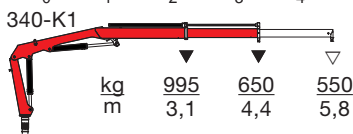
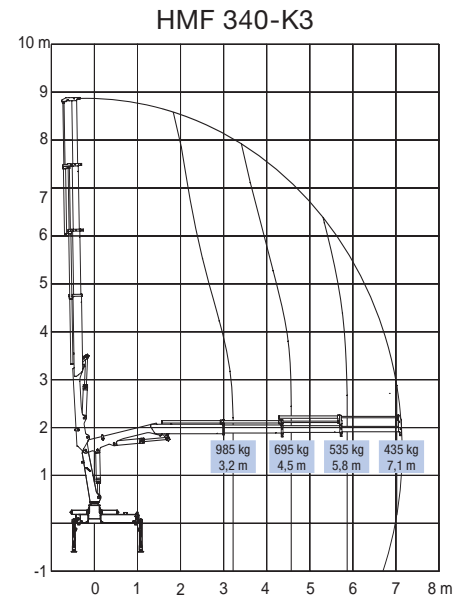
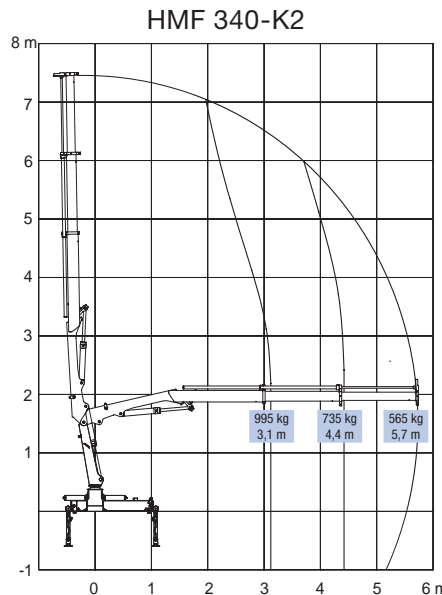
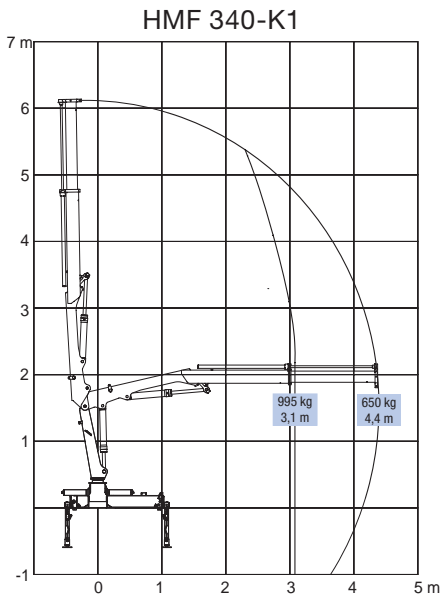

▼ Lifting capacity without manual extensions
 ▽ Lifting capacity with manual extensions

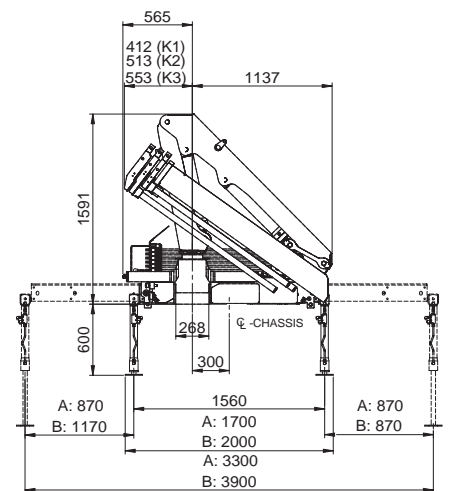
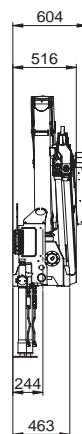

A = Stabilizer spread = 3.300

B = Stabilizer spread = 3.900



Z008076-2

We reserve the right to introduce improvements and modifications

Højbjerg Maskinfabrik A/S • Oddervej 200 • DK-8270 Højbjerg
 Tel.: +45 8627 0800 • Fax: +45 8627 0744 • info@hmf.dk

www.hmf.dk